



Make It A Better TV

HDMI • LCD • PLASMA • PROJECTORS • MONITORS

Your AV Companion



FOR STYLISH LIVING

aavara

Brochure 2009/2010

About Aavara®

Welcome to the stylish world of Aavara®, a professional brand of flat screen/panel TV wall mounts & HDMI accessory developed to help you maximise the space and lead the stylish living in your home. With modern styling inspired by the Scandinavian spirit of simplicity and robustness, the elegant design enhances the décor of your living room, home cinema, family room or wherever you want to organise your home entertainment system but without compromising on style. Aavara® is a word derived from the Finnish word avara meaning expansiveness and it is this sense of space and possibility that has been captured in the wide product range. Let Aavara® bring the elegance and sophistication you deserve to your living space.

The Aavara® Mission

Aavara®, a Taiwan based company with its logistic hub in Europe, was developed with the passionate belief that functional products can be both beautiful and durable. Combining the latest technology from the Far East with the simple sophistication of Scandinavia, Aavara® is a synergy between East and West to inspire your living space and give you the solution to your wall or ceiling mounting for business digital signage needs. With a broad range of products designed to fit large LCD/plasma/Projector/Monitor and HDMI accessories, installation is easy and straightforward enabling everyone to create a home entertainment system that makes a visual impact and gives your home the 'designer look' while maximising room space. We want you to have the best and constantly strive in the area of research and development to ensure our range of products are offering the customer the very latest in technology, design and materials.

Aavara® Innovation Corp.

Headquarter, Hsin Chu, Taiwan

www.aavara.com www.aavara.net
sales@aavara.com sales@aavara.net

Europe Logistic center, Rotterdam, The Netherlands

Geyessendorfferweg 47 3088 GJ Rotterdam The Netherlands

Aavara® is a registered trademark of Aavara® Innovation Corp. All rights reserved.

Aavara Innovation Corporation. Taiwan, R.O.C.

Aavara® Warranty Policy

To ensure the best quality and service, Aavara® always insists on the highest technology and innovation in design. Wall Support Products in the Elegant series carry a 5 year warranty and Superior & Professional series come with a 10 year warranty, and HDMI products with 2-5 year warranty



Aavara® Europe Hub - Rotterdam, The Netherlands

For serving European Warehousing and Logistics

- Freight Forwarding via Ocean, Air and Land Transportation
- Customs Brokerage – T1, T2L for EU and Non EU Countries
- Customs Clearance and Fiscal Representation
- Delivery to Door Service

Worldwide Certificates

HDMI

AAVARA® is officially listed the HIGH-DEFINITION MULTIMEDIA INTERFACE Adopter and ensure the max. compatibility of HDMI products.



VESA

A non-profit organization of Video Electronics Standards Association; AAVARA® designed products are compliant with VESA Standard.



SGS

AAVARA® lineups passed SGS TENSILE STRENGTH TEST Certificates



InfoComm

A leading non-profit association serving the PRO AV communications industry WW. AAVARA® joined InfoComm to promote PRO AV product lines.



OHIM

AAVARA® is granted the CERTIFICATE OF REGISTRATION ON TRADEMARKS AND DESIGNS for the Office for Harmonization in the European Union internal market



RoHS

AAVARA® all lineups are compliant with the RoHS-Restriction of the use of certain Hazardous Substances- Directive



TABLE of CONTENT

HDMI Market Trend	1
Digital Signage Industry News	2

HDMI SOLUTION		
HDMI Splitter	PS428	4
	PS128	4
	PS124	5
	PS122	5
HDMI Matrix	PM4x4	6
	PM4x2	6
HDMI Extender	PE121	7
	PE221	7
HDMI Switcher	SS422	8
	SW421	8
HDMI Cable	SDC10/SDC15/SDC20/SDC30	9
	PHC50/PHC100/PHC150	9

WALL SUPPORT		
Superior Series		10
ARM Support	A8050/A6041	11
	A2021/A2020	12
	AR220/AR210	13
	AR110/AR011	14
AV Support	CH630/Y2638	15

Elegant Series		16
Wall Support	EE8050/EE5040	17
	EF6540/EF4030	18
	EL6540/EL4030	19
	EF2020/EL2020	20
	EL2010/EL1010	21

Professional Series		22
Digital Signage	R9250/D9250+EF6540	23
	R9250+EF4030/EF2020	24
	PP3025	25
Desk Stand	TS011/TS742	26
	TS743/TS746/TS744	27
	POS Stand	TC/TI 210/110/011/022
	TC/TI 212/112/012/024	29

HDMI Index & Logistic data	30
HDMI Index & Logistic data	31
Superior Series Index	32
Superior Logistic Data	33
Elegant Series Index	34
Elegant Logistic Data	35
Professional Series Index	36
Professional Logistic Data	37

HDMI-A "Must Have" For Consumer Electronics

HDMI-(High-Definition Multimedia Interface) is the leading all-digital uncompressed audio/video interface. With having nearly 320million PC/CE/AV industry-supported HDMI ready devices by 2010, it becomes a de facto digital standard over other A/V standard with evolving strengths:

1. Simplicity:One digital cable replaces up to 11 analog cables, highly simplifying the setting up of a home theater as well as supporting the aesthetics of new component design with cable simplification.

2 Bandwidth: with ultimate high-bandwidth up to 10.2Gbps, HDMI 1.3 supports uncompressed digital audio for new lossless compressed digital audio formats Dolby TrueHD and DTS-HD Master Audio™.

3. Intelligence: System-wide synchronization to connect multiple HDMI devices through Consumer Electronic Control (CEC), utilizing HDMI's two- way communication to allow for single remote control of any CEC-enabled devices connected with HDMI.

4. Convergence: enabling PCs to deliver premium media content including hi-definition movies and multi-channel audio formats. HDMI is the only interface enabling connections to both HDTVs and digital PC monitors implementing the DVI and HDMI standards and 40% of all PC by 2010 supports HDMI.

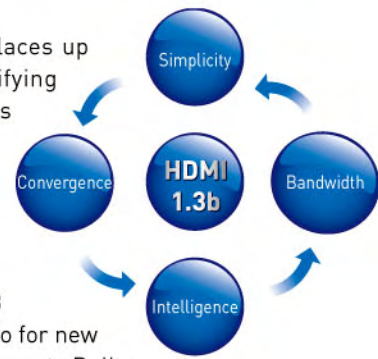

AAVARA® is proud that the HDMI lineup fully comply with 1.3 specs and dedicated all evolving leads which bring the optimized Home Theater ambiance in your home entertainment times & fulfill industry high demand.

● Global HDMI Adoption

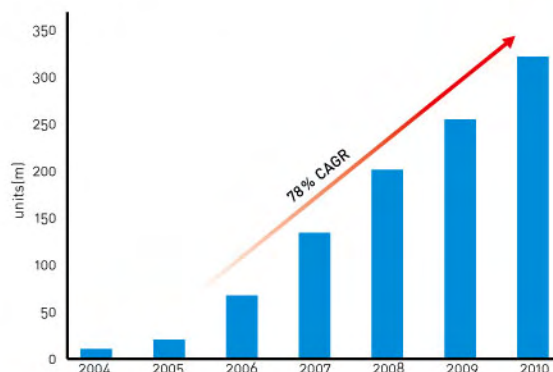

Source: HDMI.org



Digital Signage is Dominating New Wave of Display Industry

-Digital-out-of-home(DOOH), Public Display, Dynamic Signage, Electronic Billboards

With more and more affordable pricing on LCD/Plasma display, Digital Signage, known as DOOH, Public Display, becomes the most effective electronic billboards in years to come. WW Display shipment units reach 120M in 2009 and 165M by 2011. Up to 35% will be successfully adopted in digital signage public displays.

Digital signage is adopted for many different purposes, and the most common applications of digital signage such as Advertising, Public/Internal information, Brand Identity building, Influencing customer behavior and Enhancing customer experience. The benefits of Digital Signage over traditional static signs are the animated content can be exchanged more flexibly and interactively and offering superior ROI (Return on Investment) compared to traditional signs.

AAVARA® HDMI and Wall Support solutions lead the up-to-date digital signage infrastructure and advance the maximum efficiency for Digital Signage installation.

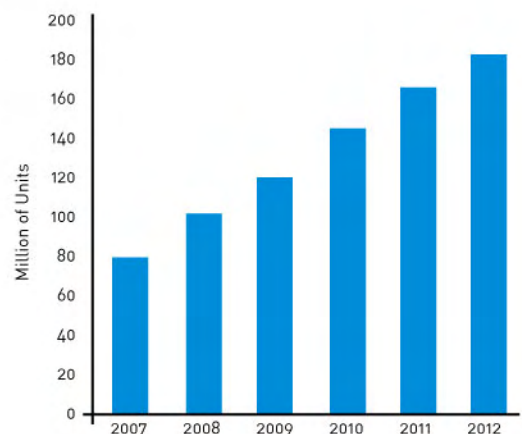



ExperTorque™ Technology

With special Allen Wrench tool included, Aavara® ExperTorque™ technology enables LCD monitor arms to be adjusted easily by display weight.



Tilt +/-20°

LCD Monitor Arm features tilt +/-20° free angle hinged by display weight, which optimized for best viewing angle.



+/-50° Spread

+/-50° Spread design for CableManagement Column making all messy cables hidden inside completely.



Extendable Length

Supporting all makes of AV device on the market with extendable arms to hold firmly.



Lateral Shift

Superior series wall mount can be shifted horizontally and effortlessly to the left or right min. 35mm from the center.

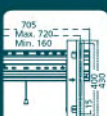

VESA Compatible

All Superior series wall mounts are VESA Compatible.



Rotation 90°

LCD Monitor Arm allows clockwise rotation easily for max. work efficiency on screen.



Swivel +/-20°

LCD Monitor Arm features swivel +/-20° free angle which optimized for best viewing angle on screen.



Smart Cable Management

With indented shape for positioning cables, it makes cables in a managed and aligned way.



Universal For All AV Devices

AV/HiFi support can hold each AV devices up to 15kg/33lbs and fit all makes of devices.



Safety Lock

Aavara® Superior A series offers a very consolidated mount solution with safetylock function to keep TV from falling especially for larger display



Tailor-made Full Screw Pack

Full Screw Pack is included in each retail box which makes unique rear bezel display easy to mount



Smart Cable Management

Aligning display cables in a tidy way by managing them at both arm channel sides.



Cable Hidden Design

Hide all cables completely in a Cable Management Column instead of tangling around the column.



Support up to 4 AV Devices

Cable Management Column is capable of supporting up to 4 set of AV device and manually adjust the device position as you desired.



Smart Cable Management

Aavara® Superior A series' dedicated design of cable holder & arm channels offering an aligned cable management system for home theater.



5 Pivot Points

Designed with heavy duty construction, Superior A series adopts 4 pivot points which make the max. swivel angle in your desired position.



Made in Taiwan

Aavara® wall mount brackets are made in Taiwan to ensure the highest quality.

SUPERIOR SERIES

Aavara® inspires you to recognise the potential within your home



A8050

LCD/ Plasma Wall Support -4 Arms with 5 Pivot Points

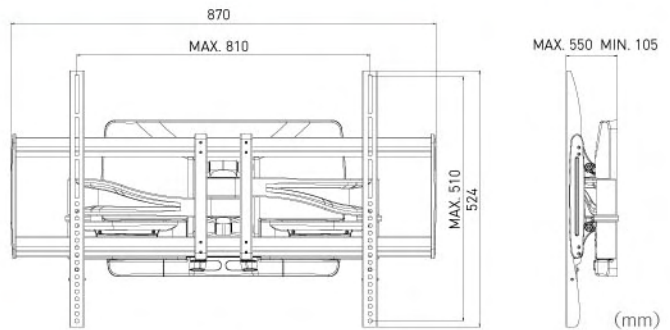

Features

- FLAT PANEL SIZE: 37"-65"/94-165cm
- LOADING CAPACITY: 85kg/187lbs
- TILT ANGLE: +/-15°
- SWIVEL ANGLE: +/-60°
- EXTENDED ARM PROVIDED: 4 Arms
- SAFETY LOCK: Yes

- CABLE MANAGEMENT: Smart Cable Management System
- MATERIAL: Steel / Aluminum
- MAX. DISTANCE TO WALL: 21.6"/ 550mm
- PRODUCT WEIGHT: 15.4kg/34lbs
- SCREW TYPE: M4,M5,M6,M8
- MAX. MOUNTING: 810*500 mm

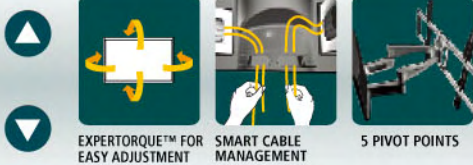

A6041

LCD/ Plasma Wall Support-4 Arms with 5 Pivot Points

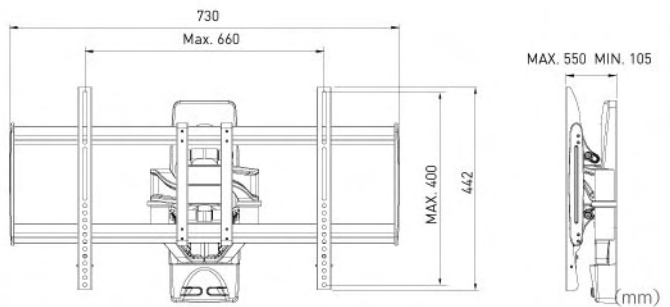

Features

- FLAT PANEL SIZE: 26"-52"/66-132cm
- LOADING CAPACITY: 50kg / 110lbs
- TILT ANGLE: +/-15°
- SWIVEL ANGLE: Max. +/-60°
- EXTENDED ARM PROVIDED: 4 Arms

- CABLE MANAGEMENT: Smart Cable Management System
- MATERIAL: Steel / Aluminum
- MAX. DISTANCE TO WALL: 21.6"/ 550mm
- PRODUCT WEIGHT: 9.9kg/21.8lbs
- SCREW TYPE: M4,M5,M6,M8
- MAX. MOUNTING: 660x400mm



A2020

LCD/ Wall Support-4 Arms with 5 Pivot Points

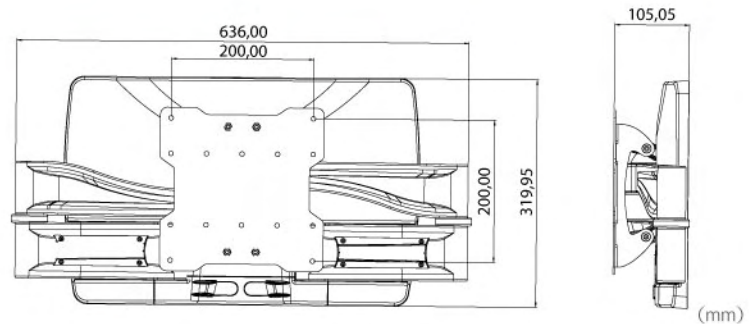

Features

- FLAT PANEL SIZE: 26"-42"/66-107cm
- LOADING CAPACITY: 60kg / 132lbs
- TILT ANGLE: +/-15°
- SWIVEL ANGLE: Max. +/-60°
- EXTENDED ARM PROVIDED: 4 Arms

- CABLE MANAGEMENT: Smart Cable Management System
- MATERIAL: Steel / Aluminum
- MAX. DISTANCE TO WALL: 21.6"/ 550mm
- PRODUCT WEIGHT: 13.3kg/29lbs
- SCREW TYPE: M4,M5,M6
- VESA COMPATIBLE: 200x200mm, 200x100mm, 100x100mm

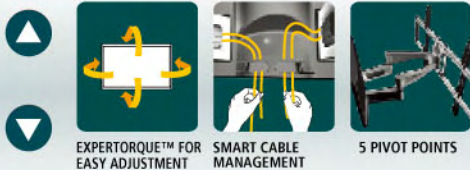

A2021

LCD/ Wall Support-4 Arms with 5 Pivot Points

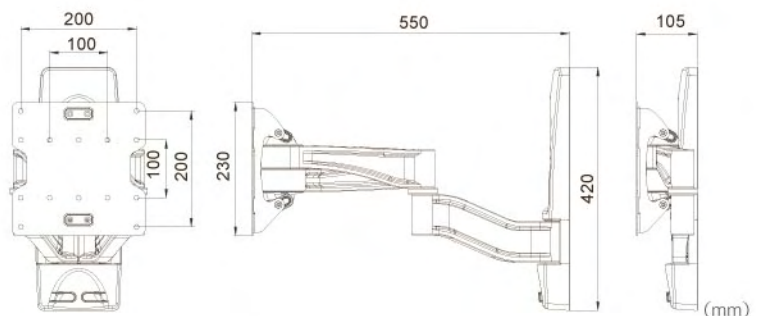

Features

- FLAT PANEL SIZE: 26"-42"/66-107cm
- LOADING CAPACITY: 50kg / 110lbs
- TILT ANGLE: +/-15°
- SWIVEL ANGLE: Max. +/-60°
- EXTENDED ARM PROVIDED: 4 Arms

- CABLE MANAGEMENT: Smart Cable Management System
- MATERIAL: Steel / Aluminum
- MAX. DISTANCE TO WALL: 21.6"/ 550mm
- PRODUCT WEIGHT: 8.9kg/19.6lbs
- SCREW TYPE: M4,M5,M6
- VESA COMPATIBLE: 200x200mm, 200x100mm, 100x100mm

SUPERIOR SERIES

Aavara® inspires you to recognise the potential within your home



ALUMINUM
ALLOY CONSTRUCTION

SUITABLE
FOR ALL
MAKES
OF TV

AR220

LCD Monitor Arm-3 Pivot Points

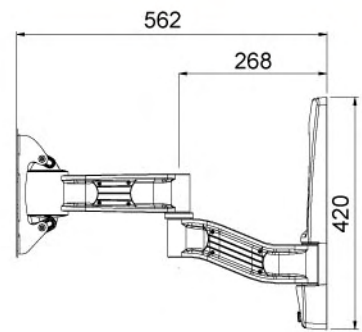
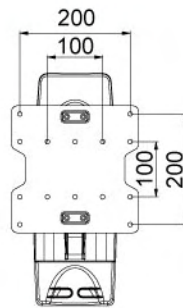

(mm)

Features

- FLAT PANEL SIZE: 22"-45"/56-114cm
- LOADING CAPACITY: 35kg / 77lbs
- TILT ANGLE: +/-15°
- SWIVEL ANGLE: +/-60°
- SCREW TYPE: M4, M5, M6
- CABLE MANAGEMENT: Smart Cable Management channels
- MATERIAL: Steel / Aluminum Alloy
- PRODUCT WEIGHT: 7.1kg/15.6lbs
- DISTANCE TO WALL: Max.22.1"/562mm
- VESA COMPATIBLE: 200x200mm, 200x100mm, 100x100mm



EXPERTORQUE™ FOR
EASY ADJUSTMENT



SMART CABLE
MANAGEMENT



EXPERTORQUE™ FOR
EASY ADJUSTMENT



ROTATION 90°



SMART CABLE
MANAGEMENT



AR210

LCD Monitor Arm- 3 Pivot Points

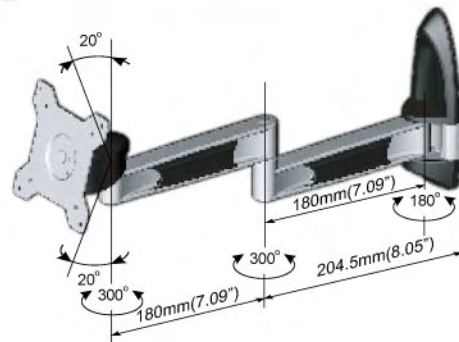

(mm)

Features

- FLAT PANEL SIZE: 15"-24"/ 38-61cm
- LOADING CAPACITY: 12kg / 26.5lbs
- TILT ANGLE: +/-20°
- SWIVEL ANGLE: +/-20°
- ROTATION: Rotate Clockwise 90°
- CABLE MANAGEMENT: Smart Cable Management channels
- MATERIAL: Steel / Aluminum Alloy
- PRODUCT WEIGHT: 1.37kg / 3lbs
- DISTANCE TO WALL: Max.17.5"/562mm
- VESA COMPATIBLE: 100*100mm / 75*75mm
- SCREW TYPE: M4

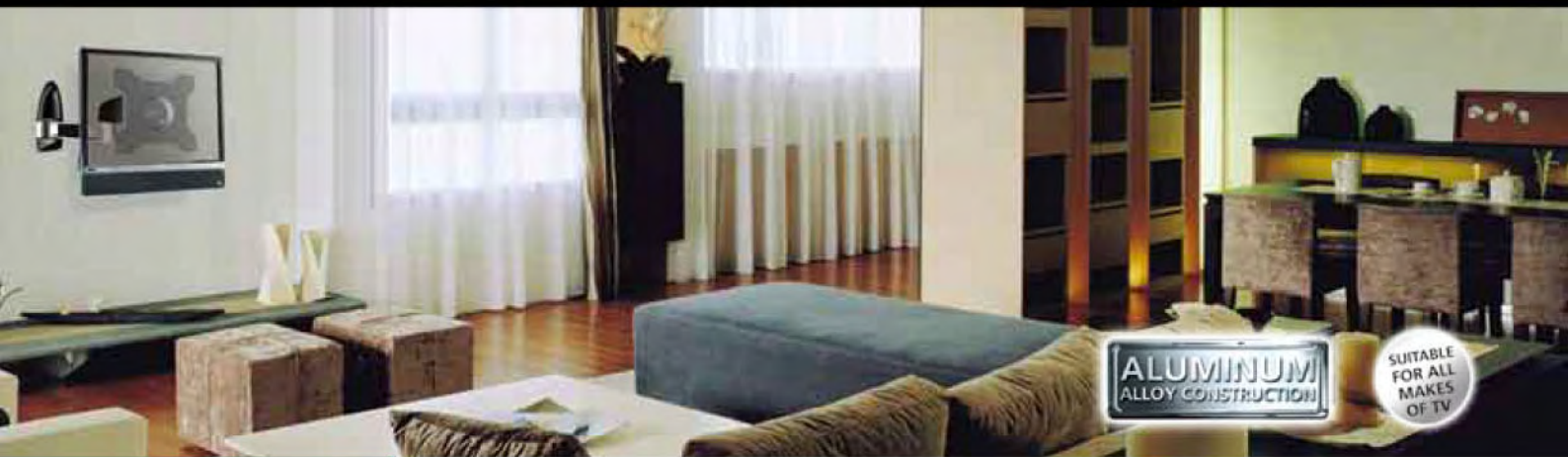

AR110

LCD Monitor Arm- 2 Pivot Points



(mm)

Features

- FLAT PANEL SIZE: 15"-24" / 38-61cm
- LOADING CAPACITY: 12kg / 26.5lbs
- TILT ANGLE: +/-20°
- SWIVEL ANGLE: +/-20°
- ROTATION: Rotate Clockwise 90°

- CABLE MANAGEMENT: Smart Cable Management channels
- MATERIAL: Steel / Aluminum Alloy
- PRODUCT WEIGHT: 1.04kg / 2.3lbs
- DISTANCE TO WALL: Max. 10.4" / 265mm
- VESA COMPATIBLE: 100*100mm / 75*75mm
- SCREW TYPE: M4



EXPERTORQUETM FOR EASY ADJUSTMENT



ROTATION 90°



SMART CABLE MANAGEMENT



ROTATION 90°



EXPERTORQUETM FOR EASY ADJUSTMENT



SAFETY LOCK



AR011

LCD Monitor Arm- 1 Pivot Point

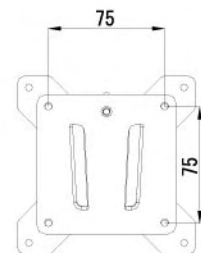
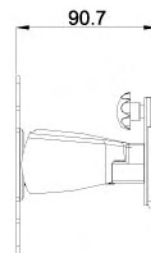
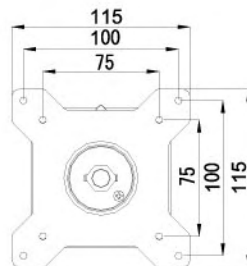

(mm)

Features

- FLAT PANEL SIZE: 15"-24" / 38-61cm
- LOADING CAPACITY: 12kg / 26.5lbs
- TILT ANGLE: +/-20°
- SWIVEL ANGLE: +/-20°
- ROTATION: Rotate Clockwise 90°

- SAFETY LOCK: Yes
- MATERIAL: Steel
- PRODUCT WEIGHT: 0.68kg / 1.5lbs
- VESA COMPATIBLE: 100*100mm / 75*75mm
- SCREW TYPE: M4

SUPERIOR SERIES

Aavara® inspires you to recognise the potential within your home



CH630

Cable Management Column

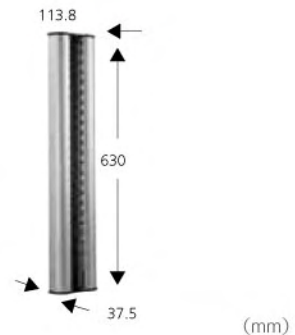

Features

- AV/ HIFI MODULAR SYSTEM
- CABLE COMPLETELY HIDDEN INSIDE
- SMART CABLE MANAGEMENT
- BEST COMBINE WITH AAVARA AV / HIFI SUPPORT
- PARALLELED SPREAD UP TO 50° FOR EASILY CABLE HIDING
- LOADING CAPACITY: Up to 4 set of AV devices (15kg each)
- MATERIAL: Aluminum alloy
- PRODUCT WEIGHT: 0.95kg / 2.1lbs
- EASY INSTALLATION: 2-EASY-STEP
- VERTICAL ADJUSTMENT: AV / HiFi Support be adjusted to desired position



CABLES COMPLETELY HIDDEN INSIDE



50° SPREAD FOR EASILY CABLE HIDING



SMART CABLE HIDDEN DESIGN



SUPPORT UP TO 4 SET AV DEVICE



110° STRETCH OUT



EXTENDED LENGTH FOR ALL AV DEVICE



FOR ALL MAKES OF AV DEVICE UP TO 15KG/33LBS



Y2638

AV/ HiFi Support

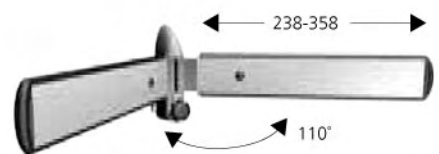

Features

- AV/ HIFI MODULAR SYSTEM
- EXTENDED LENGTH: 238-358mm
- 110° STRETCH OUT TO FIT ALL MAKES OF DEVICES
- BEST COMBINE WITH AAVARA CABLE MANAGEMENT COLUMN
- HOLD AV DEVICE STURDY & FIRMLY
- LOADING CAPACITY: 15kg / 33lbs
- MATERIAL: Aluminum alloy
- STYLISH DESIGN FOR HOME THEATER DÉCOR
- PRODUCT WEIGHT: 0.52kg / 1.14lbs
- EASY INSTALLATION: 2-EASY-STEP



Outstanding Retail Box

Aavara® creates the very eye-catching retail boxes which give user an elegant and friendly outlook and include 9 multi-language installation manual and full mounting accessory.



0°~15° Tilt

Elegant mount EF2020 enables you to tilt your display for the best viewing angle from 0°~15°.



Safety Lock

Elegant series EL2010 wall mount features holding display in place without any special tool and parts needed.



Anti-Theft Lock

with Anti-Theft Lock, it prevents TV from being stolen and enhances the advanced security in the public.



Safety Lock

Elegant series wall mount features holding display in place without any special tool and parts needed.

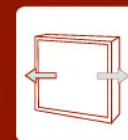

Lateral Shift

Elegant series wall mount can be shifted horizontally and effortlessly to the left or right min. 20mm from the center.

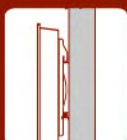

Ultra Slim Profile

Elegant series wall mount of distance to wall min. only 40mm, which gives a décor-like outlook



0°, 5°, 10°, 13°, 15° Tilt

Elegant mount enables you to tilt your display for the best viewing angle from 0°, 5°, 10°, 13°, 15°.



Ultra Slim Profile

Elegant series wall mount of EL1010 models' distance to wall min. only 20mm, which gives a décor-like outlook.

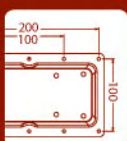

VESA Compatible

All Elegant series wall mounts are VESA Compatible.



Safety Lock

Elegant series EL/EF 2020 wall mount features holding display in place without any special tool and parts needed.

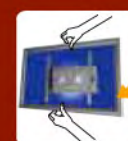

Thumb-rolling Free Tilt

Elegant EE8050, 5040 series are designed cleverly with Thumb-rolling free tilt function to flip angle as you desired effortlessly.



Smooth Finish

Chamfer metal works to make round edges and smooth finish of every details to avoid hands being cut when installing.



Tailor-made Full Screw Pack

Full Screw Pack is included in each retail box which makes unique rear bezel display easy to mount



Made in Taiwan

Aavara® wall mount brackets are made in Taiwan to ensure the highest quality.

ELEGANT SERIES

Creating a subtly AV ambiance is uppermost in Aavara®'s mind



EE8050

LCD/ Plasma Wall Support

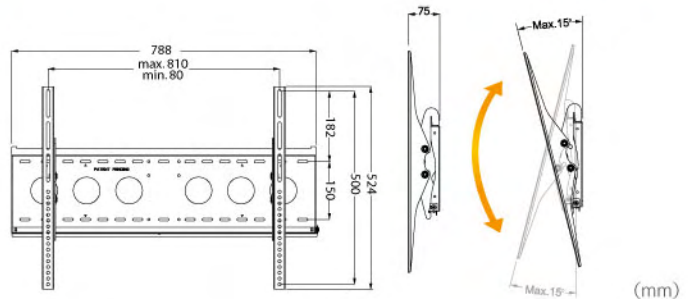

Features

- FLAT PANEL SIZE: 32" -65" / 81-165cm
- LOADING CAPACITY: 80kg/ 175lbs
- TILT ANGLE: thumb-rolling +/-15°
- ULTRA SLIM PROFILE: 2.95"/ 75mm
- MATERIAL: Steel
- LATERAL SHIFT: Slided to the left or right min. 20mm from the center
- SAFETY LOCK: Yes
- ANTI-THEFT LOCK*: Yes
- MAX. MOUNTING: 810x500mm
- PRODUCT WEIGHT: 5.2kg / 11.4lbs
- SCREW TYPE: M8, M6, M5, M4



ANTI-THEFT LOCK*



SAFETY LOCK

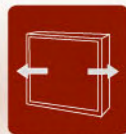

LATERAL SHIFT



THUMB-ROLLING
FREE TILT ANGLE



EE5040

LCD/ Plasma Wall Support

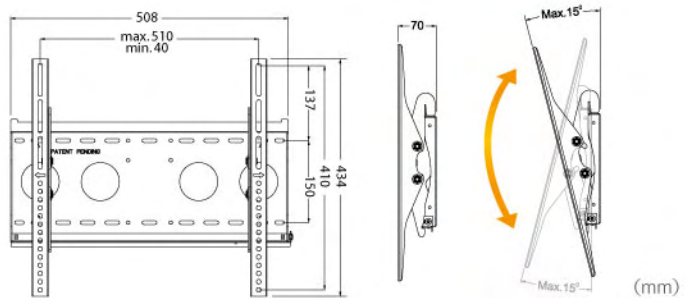

Features

- FLAT PANEL SIZE: 26" - 52" / 66-132cm
- LOADING CAPACITY: 80kg / 175lbs
- TILT ANGLE: thumb-rolling +/-15°
- ULTRA SLIM PROFILE: 2.76"/ 70mm
- MATERIAL: Steel
- LATERAL SHIFT: Slided to the left or right min. 20mm from the center
- SAFETY LOCK: Yes
- ANTI-THEFT LOCK*: Yes
- MAX. MOUNTING: 510x410mm
- PRODUCT WEIGHT: 3.9kg / 8.6lbs
- SCREW TYPE: M6, M5, M4

* Padlock is not included as it's an optional accessory



SUITABLE FOR ALL MAKES OF TV

EF6540

LCD/ Plasma Wall Support

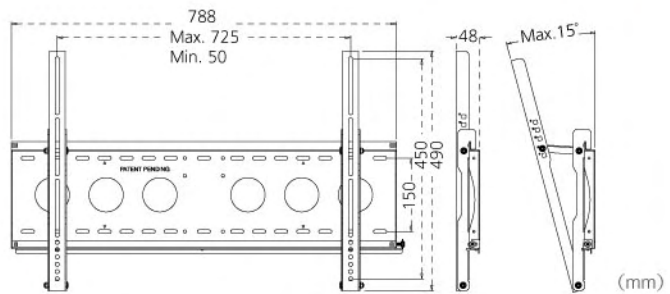

Features

- FLAT PANEL SIZE: 32" - 60" / 81-152cm
- LOADING CAPACITY: 80kg / 175lbs
- TILT ANGLE: 0°, 5°, 10°, 13°, 15°
- ULTRA SLIM PROFILE: 1.89"/48mm
- MATERIAL: Steel
- LATERAL SHIFT: Slided to the left or right min. 20mm from the center
- SAFETY LOCK: Yes
- ANTI-THEFT LOCK*: Yes
- MAX. MOUNTING: 725x450mm
- PRODUCT WEIGHT: 5.2kg / 11.4lbs
- SCREW TYPE: M8, M6, M5, M4



ANTI-THEFT LOCK*



SAFETY LOCK

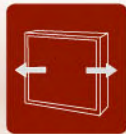

LATERAL SHIFT



ULTRA SLIM PROFILE: 48MM



0°, 5°, 10°, 13°, 15° TILT ANGLE



EF4030

LCD/ Plasma Wall Support

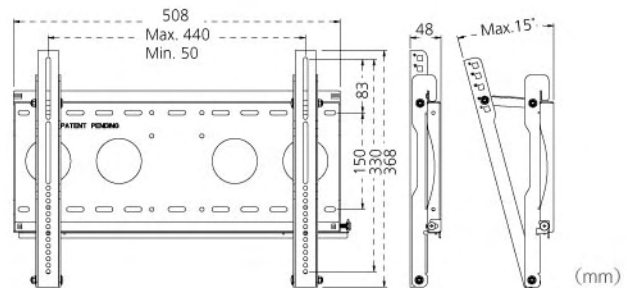

Features

- FLAT PANEL SIZE: 26" - 52" / 66-132cm
- LOADING CAPACITY: 80kg / 175lbs
- TILT ANGLE: 0°, 5°, 10°, 13°, 15°
- ULTRA SLIM PROFILE: 1.89"/48mm
- MATERIAL: Steel
- LATERAL SHIFT: Slided to the left or right min. 20mm from the center
- SAFETY LOCK: Yes
- ANTI-THEFT LOCK*: Yes
- MAX. MOUNTING: 440x330mm
- PRODUCT WEIGHT: 3.9kg / 8.6lbs
- SCREW TYPE: M6, M5, M4

ELEGANT SERIES

Creating a subtly AV ambiance is uppermost in Aavara®'s mind



EL6540

LCD/ Plasma Wall Support

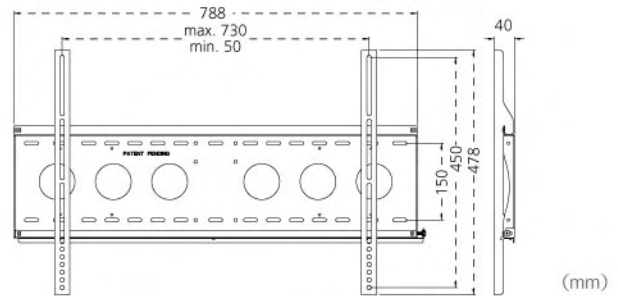

Features

- FLAT PANEL SIZE: 32" - 60" / 81-152cm
- LOADING CAPACITY: 80kg/ 175lbs
- ULTRA SLIM PROFILE: 1.57" / 40mm
- MATERIAL: Steel
- SCREW TYPE: M8, M6, M5, M4
- LATERAL SHIFT: Slided to the left or right min. 20mm from the center
- SAFETY LOCK: Yes
- ANTI-THEFT LOCK*: Yes
- MAX. MOUNTING: 730x450mm
- PRODUCT WEIGHT: 4.2kg/ 9.15lbs

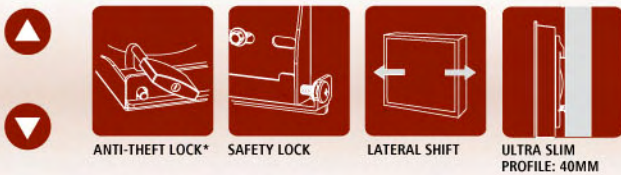

ANTI-THEFT LOCK*

SAFETY LOCK

LATERAL SHIFT

ULTRA SLIM PROFILE: 40MM



EL4030

LCD/ Plasma Wall Support

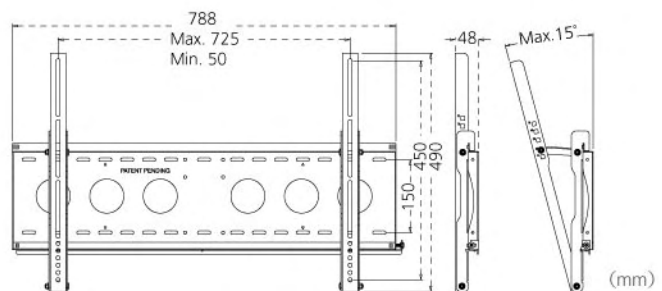

Features

- FLAT PANEL SIZE: 26" - 52" / 66-132cm
- LOADING CAPACITY: 80kg / 175lbs
- ULTRA SLIM PROFILE: 1.57"/40mm
- MATERIAL: Steel
- SCREW TYPE: M6, M5, M4
- LATERAL SHIFT: Slided to the left or right min. 20mm from the center
- SAFETY LOCK: Yes
- ANTI-THEFT LOCK*: Yes
- MAX. MOUNTING: 450x330mm
- PRODUCT WEIGHT: 2.8kg / 6.2lbs

* Padlock is not included as it's an optional accessory



EF2020

LCD Wall Support

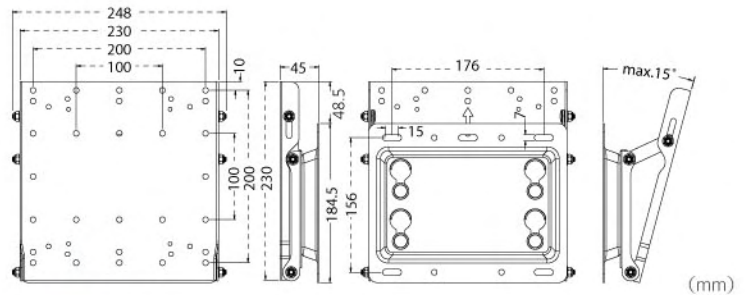

Features

- FLAT PANEL SIZE: 22" -45" / 56-114cm
- LOADING CAPACITY: 60kg / 132lbs
- TILT ANGLE: 0°-15° free angle
- ULTRA SLIM PROFILE: 1.77"/ 45mm
- MATERIAL: Steel
- SAFETY LOCK: Yes
- MAX. MOUNTING: 200x200mm
- PRODUCT WEIGHT: 2kg / 4.4lbs
- SCREW TYPE: M6,M5,M4



ULTRA SLIM
PROFILE: 45MM



0°-15°
FREE ANGLE

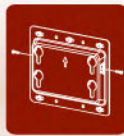

SAFETY LOCK



ULTRA SLIM
PROFILE: 40MM

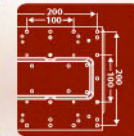

200x200/200x100/
100x100MM

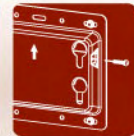

SAFETY LOCK



EL2020

LCD Wall Support

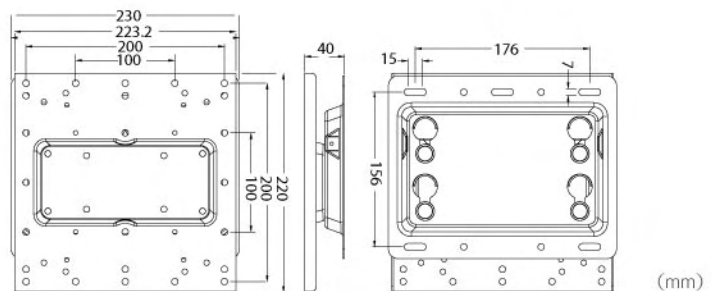

Features

- FLAT PANEL SIZE: 22" -45" / 56-114cm
- LOADING CAPACITY: 60 kg / 132 lbs
- ULTRA SLIM PROFILE: 1.57"/ 40mm
- MATERIAL: Steel
- SAFETY LOCK: Yes
- MAX. MOUNTING: 200x200mm
- PRODUCT WEIGHT: 1.45kg / 3.2lbs
- SCREW TYPE: M6,M5,M4

ELEGANT SERIES

Creating a subtly AV ambiance is uppermost in Aavara®'s mind



SUITABLE FOR ALL MAKES OF TV

EL2010

LCD Wall Support

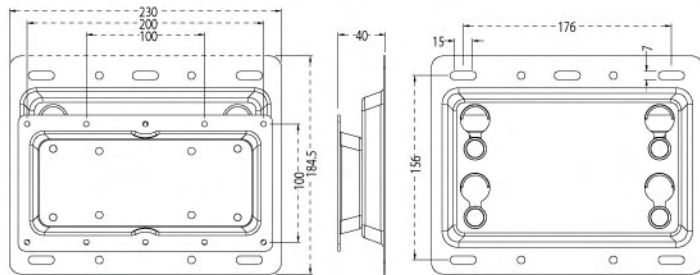

(mm)

Features

- FLAT PANEL SIZE: 17"-32" / 43-81cm
- LOADING CAPACITY: 60kg/ 132lbs
- ULTRA SLIM PROFILE: 1.57" / 40mm
- MATERIAL: Steel
- SAFETY LOCK: Yes
- MAX. MOUNTING: 200x100mm
- PRODUCT WEIGHT: 1kg/ 2.2lbs
- SCREW TYPE: M4



ULTRA SLIM PROFILE: 40MM

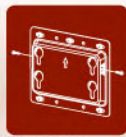

SAFETY LOCK

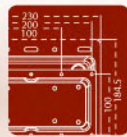

200x100/
100x100MM



ULTRA SLIM PROFILE: 20MM

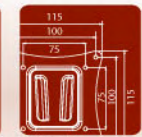

100x100/
75x75MM



EL1010

LCD Wall Support

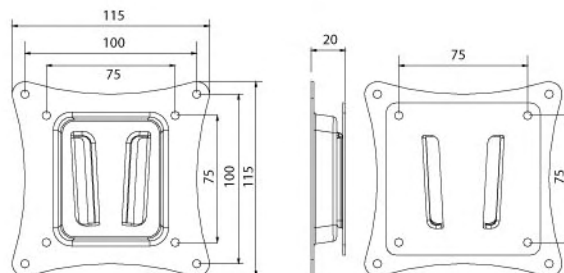

(mm)

Features

- FLAT PANEL SIZE: 17" - 23" / 43-58cm
- LOADING CAPACITY: 30kg / 65lbs
- ULTRA SLIM PROFILE: 0.78" / 20mm
- MATERIAL: Steel
- MAX. MOUNTING: 100x100mm
- PRODUCT WEIGHT: 0.26kg / 0.57lbs
- SCREW TYPE: M4

Aavara® Pro Series fulfills public display needs and optimized for prosumers

Multiple Monitor Stand



Projector Hanger



Ceiling Support



Horizontal & Vertical +/-10°

Projector hanger features free tilt +/-10° optimized for best projecting viewing angle



360° Rotation

The horizontal angle can be set with a range of 360° to any of your desired direction.



Tube Length Adjustable

Projector hanger's adjustable length from 116~578mm with 20.5mm fine increment to your desired position.



Universal For All Projectors

Projector hanger is designed for suitable for all makes of projectors in a hole pattern compatible within 350mm



Anti-Theft Lock

with Anti-Theft Lock, it prevents TV from being stolen and enhances the advanced security in the public.



Safety Lock

Ceiling mount features holding display in place without any special tool and parts needed.



Lateral Shift

Ceiling mount can be shifted horizontally and effortlessly to the left or right min. 20mm from the center.

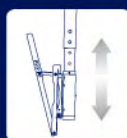

Tube Length Adjustable & Cable Management

Flexibly adjusted length 924~1424mm in 50mm increment without compromising to limited space and featuring cable management inside tube.



0°, 5°, 10°, 13°, 15° Tilt

Ceiling mount enables you to tilt your display for the best viewing angle from 0°, 5°, 10°, 13°, 15°.



90° Rotation

Dual/Quattro Flip Stand allows clockwise rotation easily for max. work efficiency on screen.



Tilt +/-20°

Dual/Quattro Flip Stand features tilt +/-20° free angle hinged by display weight, which optimized for best viewing angle.



Swivel +/-20°

Dual/Quattro Flip Stand features swivel +/-20° free angle which optimized for best viewing angle on screen.



ExperTorque™ Technology

With special Allen Wrench tool included, Aavara® ExperTorque™ technology enables Dual/Quattro to be adjusted easily by display weight.



Smart Cable Management

With cable holder system design on the back, it can position multiple monitors' cables in a managed and aligned way.

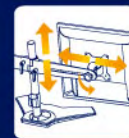

Horizontal & Vertical Shift

Dual/Quattro Flip Stand series offers a Horizontal & Vertical Shift to make the most of work efficiency on screen.



R9250+EF6540

LCD/ Plasma Ceiling Mount

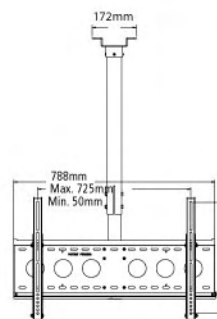

(mm)

Features

- FLAT PANEL SIZE: 32" -60" / 81-152cm
- LOADING CAPACITY: 60kg/ 132lbs
- TILT ANGLE: 0°, 5°, 10°, 13°, 15°
- MATERIAL: Steel
- ROTATION: 360°

- HEIGHT ADJUSTMENT: 924mm to 1,424mm in 50mm increments
- SAFETY LOCK: Yes
- ANTI-THEFT LOCK*: Yes
- MAX. MOUNTING: 725x450mm
- PRODUCT WEIGHT: 11.4kg / 25lbs
- SCREW TYPE: M8, M6, M5, M4



ANTI-THEFT LOCK*

SAFETY LOCK

ADJUSTABLE LENGTH:
924-1,424MM

0°, 5°, 10°, 13°, 15°
TILT ANGLE



D9250+EF6540*2

Dual LCD/ Plasma Ceiling Mount

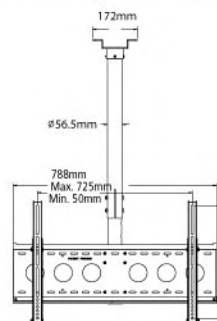

(mm)

Features

- FLAT PANEL SIZE: 32" -60" / 81-152cm
- LOADING CAPACITY: 60kg/ 132lbs per side
- TILT ANGLE: 0°, 5°, 10°, 13°, 15°
- MATERIAL: Steel
- ROTATION: 360°

- HEIGHT ADJUSTMENT: 924mm to 1,424mm in 50mm increments
- SAFETY LOCK & ANTI-THEFT LOCK*: Yes
- MAX. MOUNTING: 725x450mm
- PRODUCT WEIGHT: 16kg / 36.4lbs
- SCREW TYPE: M8, M6, M5, M4

*Padlock is not included as it's an optional accessory.



R9250+EF4030

LCD/ Plasma Ceiling Mount

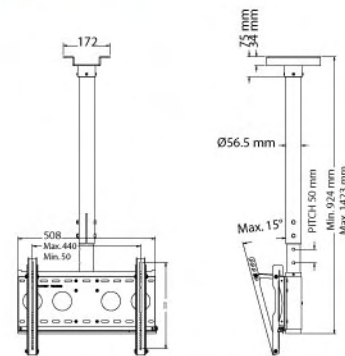

(mm)

Features

- FLAT PANEL SIZE: 26" -52" / 66 -132cm
- LOADING CAPACITY: 60kg / 132lbs
- TILT ANGLE: 0°,5°,10°,13°,15°
- MATERIAL: Steel
- ROTATION: 360°
- HEIGHT ADJUSTMENT: 924mm to 1,424mm in 50mm increments
- SAFETY LOCK: Yes
- ANTI-THEFT LOCK*: Yes
- MAX. MOUNTING: 440X330mm
- PRODUCT WEIGHT: 9.8kg / 21.6lbs
- SCREW TYPE: M6,M5,M4



ANTI-THEFT LOCK*



SAFETY LOCK



ADJUSTABLE LENGTH:
924-1,424MM



0°, 5°, 10°, 13°, 15°
TILT ANGLE



ADJUSTABLE LENGTH:
924-1,424MM



0°~15°
FREE ANGLE



R9250+EF2020

LCD Ceiling Mount

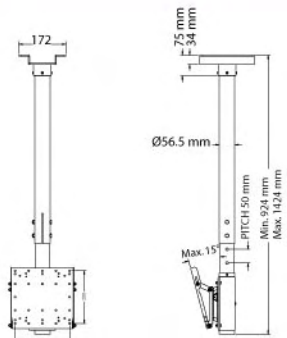

(mm)

Features

- FLAT PANEL SIZE: 22" -45" / 56 - 114cm
- LOADING CAPACITY: 60kg/ 132lbs
- TILT ANGLE: 0°~20°
- MATERIAL: Steel
- ROTATION: 360°
- HEIGHT ADJUSTMENT: 924mm to 1,424mm in 50mm increments
- SAFETY LOCK : Yes
- MAX. MOUNTING: 200x200mm
- PRODUCT WEIGHT: 7.9kg / 17.4lbs
- SCREW TYPE: M6,M5,M4



PP3025

Projector Hanger



HORIZONTAL/VERTICAL 360° ROTATION
INCLINATION +/-10°



ADJUSTABLE LENGTH
116MM-578MM



COMPATIBLE WITH
DIAMETER 350MM

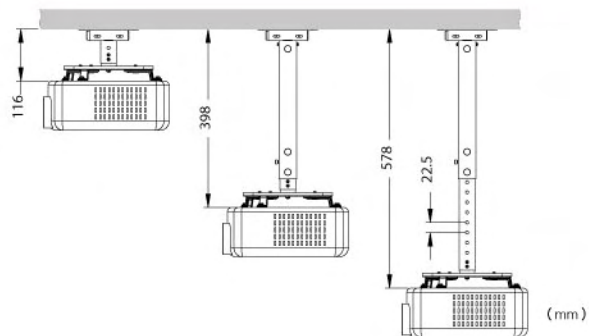
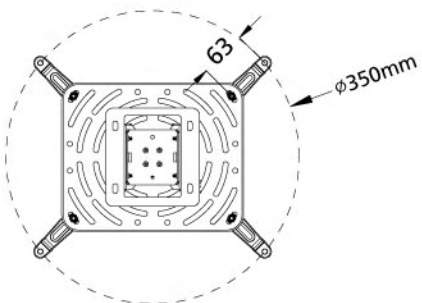

Features

- **LOADING CAPACITY:** 15kg / 33lbs
- **TILT ANGLE:** Up to +/-10° Tilt
- **MATERIAL:** Steel
- **ADJUSTABLE LENGTH:** 116mm~578mm
- **MAX. MOUNTING:** Diameter Ø350mm
- **PRODUCT WEIGHT:** 1.9kg / 4.2lbs
- **SCREW TYPE:** M2.6, M3, M4, M5
- **FLEXIBLE INCREMENT:** 22.5mm



TS011

LCD Monitor Stand

* depend on size of your display



★ OPTIONAL DESK/GROMMET BASE

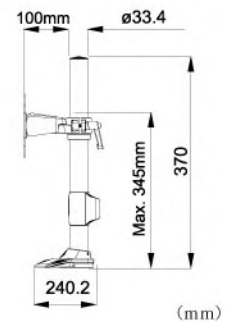
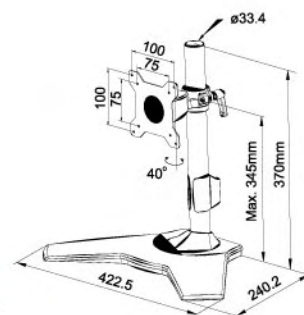

Features

- FLAT PANEL SIZE: 15"-24" / 38-61cm
- LOADING CAPACITY: 12kg / 26.5lbs for each display
- TILT & SWIVEL ANGLE: +/-20°
- LENGTH ADJUSTMENT: Yes
- CABLE MANAGEMENT: Smart Cable Management System
- ExperTorque™: ExperTorque™ design for easy adjustment hinged by monitor weight
- MATERIAL: Steel / Aluminum
- PRODUCT WEIGHT: 3.5kg / 7.7lbs
- ROTATION: 90°
- SCREW TYPE: M4
- VESA COMPATIBLE: 100*100mm / 75*75mm



OPTIONAL DESK CLAMP BASE



OPTIONAL GROMMET MOUNT BASE



ROTATION 90°



EXPERTORQUE™ FOR EASY ADJUSTMENT



SMART CABLE MANAGEMENT SYSTEM



HORIZONTAL & VERTICAL SHIFT*



TS742

Dual LCD Monitor Stand

* depend on size of your display



★ OPTIONAL DESK/GROMMET BASE

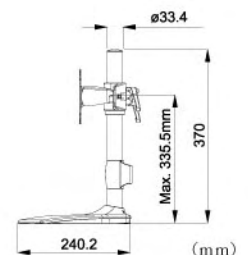
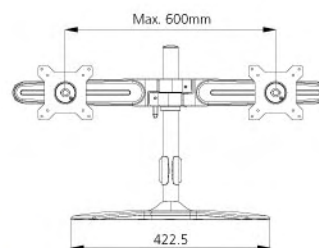

Features

- FLAT PANEL SIZE: 15"-24" / 38-61cm
- LOADING CAPACITY: 12kg / 26.5lbs for each display
- TILT & SWIVEL ANGLE: +/-20°
- HORIZONTAL & VERTICAL SHIFT: Yes*
- CABLE MANAGEMENT: Smart Cable Management System
- ExperTorque™: ExperTorque™ design for easy adjustment hinged by monitor weight
- MATERIAL: Steel / Aluminum
- PRODUCT WEIGHT: 2.1kg/4.6lbs
- ROTATION: 90°
- SCREW TYPE: M4
- VESA COMPATIBLE: 100*100mm / 75*75mm
- ARM ADJUSTMENT: 2 independent swing arms enable max. work efficiency on screen*

PROFESSIONAL SERIES

Multiple monitor stands enable the max. work efficiency for prosumers



ALUMINUM
ALLOY CONSTRUCTION

SUITABLE
FOR ALL
MAKES
OF TV

TS743 / TS746

3/ 6 LCD Monitor Stand

* depend on size of your display

TS743



★ OPTIONAL DESK/GROMMET BASE

TS746



★ OPTIONAL DESK/GROMMET BASE



OPTIONAL DESK CLAMP BASE

OPTIONAL GROMMET MOUNT BASE

ROTATION 90°

EXPERTORQUE™ FOR EASY ADJUSTMENT

SMART CABLE MANAGEMENT SYSTEM

HORIZONTAL & VERTICAL SHIFT*



TS744

Quad LCD Monitor Stand

* depend on size of your display



★ OPTIONAL DESK/GROMMET BASE

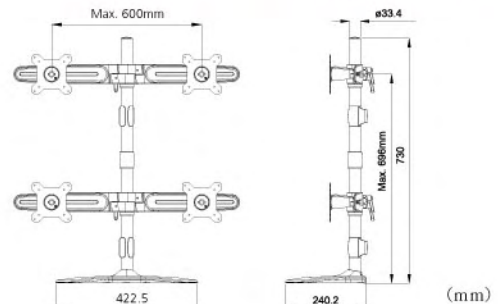

Features

- FLAT PANEL SIZE: 15"-24" / 38-61cm
- LOADING CAPACITY: 12kg / 26.5lbs for each display
- TILT & SWIVEL ANGLE: +/-20°
- HORIZONTAL & VERTICAL SHIFT: Yes*
- CABLE MANAGEMENT: Smart Cable Management System
- ExperTorque™: ExperTorque™ design for easy adjustment hinged by monitor weight

- MATERIAL: Steel / Aluminum
- PRODUCT WEIGHT: 6.37kg / 14lbs
- ROTATION: 90°
- SCREW TYPE: M4
- VESA COMPATIBLE: 100*100mm / 75*75mm
- ARM ADJUSTMENT: 4 independent swing arms enable max. work efficiency on screen*



CLAMP/ GROMMET BASED STAND

Professional POS Lineups

TI011



TI022



TI110



TI210

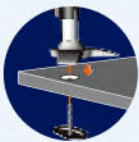

Grommet Base

TC011



TC022



TC110



TC210



Clamp Desk Base



OPTIONAL DESK CLAMP BASE



OPTIONAL GROMMET MOUNT BASE



ROTATION 90°



EXPERTORQUE™ FOR EASY ADJUSTMENT



SMART CABLE MANAGEMENT SYSTEM



LENGTH ADJUSTMENT



EXTENDED LENGTH



Features

- FLAT PANEL SIZE: 15"-24" / 38-61cm
- LOADING CAPACITY: 8kg / 17.6lbs* for each display
- TILT & SWIVEL ANGLE: +/-20°
- LCD MONITOR BASE OPTIONS: Clamp or Grommet
- CABLE MANAGEMENT: Smart Cable Management System
- ExpertTorque™: ExpertTorque™ design for easy adjustment hinged by monitor weight
- MATERIAL: Steel / Aluminum
- LENGTH ADJUSTMENT: Yes
- ROTATION: 90°
- SCREW TYPE: M4
- VESA COMPATIBLE: 100*100mm / 75*75mm
- ARM POVITS: 2 Joints in TC/TI110
3 Joints in TC/TI210
- * TC/TI210: 6kg/13.2lbs for each display

PROFESSIONAL SERIES

Optimized POS Stand solutions to achieve max. work efficiency



EXTENDED POLE POS STAND

Professional POS Lineups

TI012



TI024



TI112



TI212



TC012



TC024



TC112



TC212

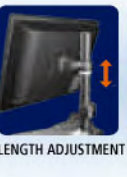
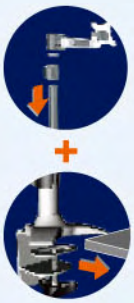
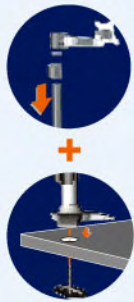

Features

- FLAT PANEL SIZE: 15" -24" / 38-61cm
- LOADING CAPACITY: 6kg / 13.2lbs for each display
- TILT & SWIVEL ANGLE: +/-20°
- LCD MONITOR BASE OPTIONS: Clamp or Grommet
- CABLE MANAGEMENT: Smart Cable Management System
- ExpertTorque™: ExpertTorque™ design for easy adjustment hinged by monitor weight
- MATERIAL: Steel / Aluminum
- EXTENDED POLE: Support up to 4 LCD Monitor Stands
- ROTATION: 90°
- SCREW TYPE: M4
- VESA COMPATIBLE: 100*100mm / 75*75mm
- ARM JOINTS: 2 Joints in TC/TI112
3 Joints in TC/TI212